



EHL PROLIST

Din listdistributör med oslagbar flexibilitet

Avvikande dimensioner

Har ni behov av andra dimensioner än de som finns i vårt sortiment har vi möjlighet att ta fram dessa.

Exaktkapningar

Vet ni att era kunder behöver exakta mått kan vi ombesörja det och underlätta för er.

Kundspecifika kulörer

Vi har möjlighet att ta fram listverk med andra kulörer om så önskas.

Kundspecifika profiler (verktyg)

Vi kan ta fram verktyg till specifika profiler.

Andra träslag

Vi kan även erbjuda fler träslag än de som finns i sortimentslistan, kontakta oss för offert.

Rengöring – använd ett mildt rengöringsmedel och en lätt fuktad trasa.

Övermålningsbar – rugga upp ytan som är vaxliknande. Detta gör att ny färg får lättare att fästa. Applicera därefter ny färg. Alternativt välj våra grundmålade lister.

Furu obh	obehandlad furu	typ A
Furu B	obehandlad furu	typ B
Furu vit	Ncs S 0502-Y	glans 25-30
Furu vit	Ncs S 0500-N	glans 25-30
MDF vit	Ncs S 0502-Y	glans 25-30
Lackad Ek	Klarlack	glans 25-30
Furu grundmålade – grundmålade vit för enklare övermålning efter lätt slipning		

Om du inte hittar vad du söker tar vi gärna fram andra alternativ vad gäller kulörer, dimensioner, träslag och profiler!



EHL Prolist AB	Rindalslist AS
Prolist Nordic AB	Eesti Höövelliist OÜ
Grimslöv Trä och List AB	Liistuvabrik OÜ

Våra vitmålade furu- och MDF-lister är bedömda i SundaHus Miljödata



Intertek



För certifieringar och kvalitetsdokument – se vår hemsida www.ehlprolist.se

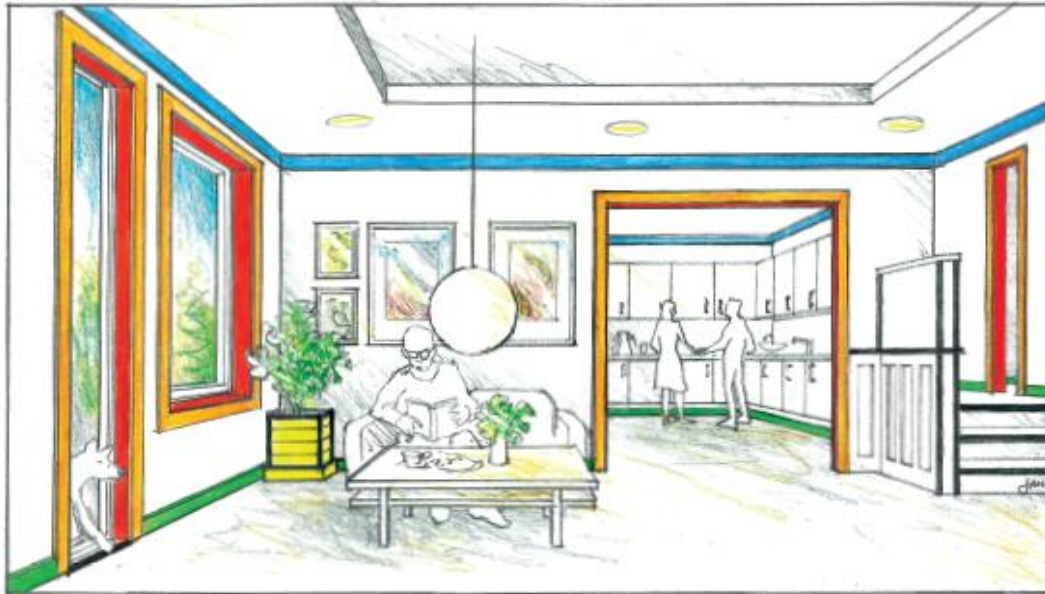

HITTA RÄTT LIST

Följ färgkodningen för att hitta den list ni söker

FODER

Foder används runt fönster och dörrar för att täcka skarven mellan karm och vägg.

SOCKEL

Sockel används för att täcka springor mellan golv och vägg.

TAKLIST

Taklist används i övergången mellan tak och vägg för att täcka springor.

ÖVRIGA LISTER

Övriga lister används primärt för att täcka springor och skarvar, till exempel Foglist, Smyglist, Kvarstäv, Rundstäv mm.

FÖNSTERSMYG/DÖRRUMFATTNING

Fönstersmyg används vid montering av fönster och dörrar som utsalning mot vägg. Dörrumfattning används där det saknas karm i dörrhål och valv.

PLANHYVLAT

Planhyvlat har många användningsområden. Planhyvlat används ofta vid utsalning av fönster och dörrar och till allmänna snickerier.

Innehåll









Foder slät	1
Klackfoder	2
Foder, profilerade	2
Sockel	3
Sockel, profilerade	4
Taklister	5
Bröstlister	7
Hörnlistor	7
Flexilist MDF	7
Salningslister	7
Smyglister	8
Falsad fönstersmyg Furu	9
Spårad fönstersmyg MDF	9
Falsad fönstersmyg MDF	10
Dörromfattning MDF	10
Foglister/Täckbräda	11
Rundstav	11
Kvartstav	12
Halvstav	12
Trekantslist	13
Kakellist	13
U-list	13
Glaslist	13
Dekorlist	13
Klossar	13
Kortlister	14
Planhyvlat	15
Lister MDF	17
Clips/Bättringsfärg	17
Bastuartiklar	17
Lustejp	18
Diverse	18
Monteringsanvisning	19
Samtliga lister i 0500-N	19
Samtliga lister i grundmålat	21
SimSalaBimlisten	21

	Foder slät	Dimension mm	Beskrivning	Enhet/bunt	Enhet
	200144	10x43x4400	Foder vit	10 st	
	200344	10x56x4400	Foder vit	10 st	
	200311	10x56x1100	Foder vit	5 st	
	300344	10x56x4400	Foder vit 0500-N	10 st	
	200444	10x69x4400	Foder vit	10 st	
	200644	12x43x4400	Foder vit	10 st	
	2006	12x43x2200	Foder vit	10 st	
	300544	12x43x4400	Foder vit 0500-N	10 st	
	200722	12x43x2200	Foder vit 0500-N	10 st	
	5005	12x43	Foder obh	28 lpm	
	5006	12x43x2200	Foder obh	10 st	
	9202	12x43	Foder grundmålåd	44 lpm	
	4005	12x44	Foder Ek lackad	52 lpm	
	201044	12x56x4400	Foder vit	10 st	
	2010	12x56x2200	Foder vit	10 st	
	201027	12x56x2700	Foder vit	10 st	
	201036	12x56x3600	Foder vit	10 st	
	301130	12x56x3600	Foder vit 0500-N	10 st	
	301144	12x56x4400	Foder vit 0500-N	10 st	
	201122	12x56x2200	Foder vit 0500-N	10 st	
	201127	12x56x2700	Foder vit 0500-N	10 st	
	5008	12x56	Foder obh	28 lpm	
	5010	12x56x2200	Foder obh	10 st	
	9008	12x56	Foder grundmålåd	44 lpm	
	9010	12x56x2200	Foder grundmålåd	10 st	
	6008	12x56	Foder Ek lasyr	28 lpm	
	4008	12x56	Foder Ek lackad	35 lpm	
	4010	12x56x2200	Foder Ek lackad	10 st	
	401011	12x56x1100	Foder Ek lackad	5 st	
	7508	12x58x4000	Foder Ekfanerad lackad	10 st	
	7510	12x58x2200	Foder Ekfanerad lackad	10 st	
	4930	12x56	Foder Björk lackad	35 lpm	
	493022	12x56x2200	Foder Björk lackad	10 st	
	4950	12x56mm	Foder Bok lackad	35 lpm	
	495022	12x56x2200	Foder Bok lackad	10 st	
	2009	12x56x2200+1100	Foderset vit	1 st	
	200900	12x56x2200+1100	Foderset vit 0500-N	1 st	
	5009	12x56x2200+1100	Foderset obh	1 st	
	201444	12x69x4400	Foder vit	10 st	
	2014	12x69x2200	Foder vit	10 st	
	301944	12x69x4400	Foder vit 0500-N	10 st	
	201922	12x69x2200	Foder vit 0500-N	10 st	
	5013	12x69	Foder obh	28 lpm	
	5014	12x69x2200	Foder obh	10 st	
	9013	12x69	Foder grundmålåd	44 lpm	
	4013	12x69	Foder Ek lackad	28 lpm	
	2012	12x69x2200+1100	Foderset vit	1 st	
	201644	12x95x4400	Foder vit	10 st	
	301544	12x95x4400	Foder vit 0500-N	10 st	

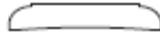

Foder slät, forts.	Dimension mm	Beskrivning	Enhet/bunt	Enhet
	2016 12x95x2200	Foder vit	10 st	
	201600 12X95X2200	Foder vit 0500-N	10 lpm	
	5015 12x95	Foder obh	28 lpm	
	5016 12x95x2200	Foder obh	10 st	
	9017 15x33	Foder grundmålad	44 lpm	
	201744 15x56x4400	Foder vit	8 st	
	2018 15x56x2200	Foder vit	10 st	
	302044 15x56x4400	Foder vit 0500-N	8 st	
	202222 15x56x2200	Foder vit 0500-N	10 st	
	202044 15x69x4400	Foder vit	8 st	
	2021 15x69x2200	Foder vit	10 st	



Klackfoder	Dimension mm	Beskrivning	Enhet/bunt	Enhet
	204044 15x56x4400	Klackfoder vit	10 st	
	204144 21x43x4400	Klackfoder vit	10 st	
	5041 21x43	Klackfoder obh	28 lpm	
	204244 21x56x4400	Klackfoder vit	10 st	
	5042 21x56	Klackfoder obh	28 lpm	
	2043 21x56x2200	Klackfoder vit	8 st	
	304244 21x56x4400	Klackfoder vit 0500-N	10 st	
	5043 21x56x2200	Klackfoder obh	10 st	









Foder, profilerade	Dimension mm	Beskrivning	Enhet/bunt	Enhet
	5020 15x56	Foder Furu obh/Skrea	28 lpm	
	202444 15x69x4400	Allmogefoder vit (286)	8 st	
	302444 15x69x4400	Allmogefoder 0500-N (286)	8 st	
	5023 15x69	Allmogefoder obh (286)	28 lpm	
	5323 15x69	Allmogefoder obh B (286)	18 lpm	
	2024 15x69x2200	Allmogefoder vit (286)	10 st	
	3024 15x69x2200	Allmogefoder 0500-N (286)	10 st	
	5024 15x69x2200	Allmogefoder obh (286)	10 st	
	202644 15x95x4400	Allmogefoder vit (287)	8 st	
	302644 15x95x4400	Allmogefoder 0500-N (287)	8 st	
	5025 15x95	Allmogefoder obh (287)	28 lpm	
	2026 15x95x2200	Allmogefoder vit (287)	5 st	
	5026 15x95x2200	Allmogefoder obh (287)	5 st	
	5028 15x95	Allmogefoder obh B (287)	18 lpm	
	5029 21x120	Allmogefoder obh (287)	18 lpm	
	203144 15x69x4400	Allmogefoder vit (289)	8 st	
	5031 15x69	Allmogefoder obh (289)	18 lpm	
	903844 21x95x4400	Allmogefoder grundmålad 343	5 st	
	202744 15x69x4400	Allmogefoder vit (290)	8 st	
	5027 15x69	Allmogefoder obh (290)	18 lpm	

Foder profilerade, forts	Dimension mm	Beskrivning	Enhet/bunt	Enhet
	203344 15x69x4400 5033 15x69	Allmogefoder vit (291) Allmogefoder obh (291)	8 st 18 lpm	
	203444 15x95x4400 5034 15x95	Allmogefoder vit (296) Allmogefoder obh (296)	8 st 18 lpm	
	202944 21x69x4400	Allmogefoder vit (298)	8 st	
	203044 21x95x4400 5030 21x95	Allmogefoder vit (307) Allmogefoder obh (307)	5 st 15 lpm	
	203544 15x69x4400 5035 15x69	Allmogefoder vit (295) Allmogefoder obh (295)	8 st 18 lpm	
	203644 15x95x4400 5036 15x95	Allmogefoder vit (239) Allmogefoder obh (239)	8 st 18 lpm	
	206044 21x95x4400 5060 21x95 5061 21x120 5160 21x95 5161 21x120	Allmogefoder West vit Allmogefoder West obh Allmogefoder West obh Allmogefoder West gran Allmogefoder West gran	5 st 18 lpm 18 lpm 18 lpm 18 lpm	
	206244 15x69x4400 206222 15x69x2200 5062 15x69 506222 15x69x2200	Allmogefoder Syd vit Allmogefoder Syd vit Allmogefoder Syd obh Allmogefoder Syd obh	8 st 10 st 18 lpm 10 st	
	206344 15x95x4400 206322 15x95x2200 5063 15x95 506322 15x95x2200	Allmogefoder Syd vit Allmogefoder Syd vit Allmogefoder Syd obh Allmogefoder Syd obh	8 st 10 st 18 lpm 10 st	
	5038 21x95	Allmogefoder obh 343	18 lpm	
	2223 13x69 2224 15x95	Antikfoder furu vit Antikfoder furu vit	35,2 lpm 22 lpm	











Socket	Dimension mm	Beskrivning	Enhet/bunt	Enhet
	220244 12x43x4400	Socket vit	10 st	
	320244 12x43x4400 5202 12x43 9201 12x43 4202 12x44	Socket vit 0500-N Socket obh Socket grundmålad Socket Ek lackad	10 st 28 lpm 44 lpm 42 lpm	
	220444 12x56x4400	Socket vit	10 st	
	2204300 12x56x3000	Socket vit	10 st	
	2204360 12x56x3600	Socket vit	10 st	
	320344 12x56x4400	Socket vit 0500-N	10 st	
	320330 12x56x3000	Socket vit 0500-N	10 st	
	5204 12x56	Socket obh	28 lpm	

Sockel, forts		Dimension mm	Beskrivning	Enhet/bunt	Enhet
	9204	12x56	Sockel grundmålad	35	lpm
	6204	12x56	Sockel Eklasyr	28	lpm
	4204	12x56	Sockel Ek lackad	42	lpm
	7704	12x58x4000	Sockel Ekfanerad lackad	10	st
	4931	12x56	Sockel Björk lackad	35	lpm
	4951	12x56	Sockel Bok lackad	35	lpm
	220544	12x69x4400	Sockel vit	10	st
	220536	12x69x3600	Sockel vit	10	st
	320744	12x69x4400	Sockel vit 0500-N	10	st
	5205	12x69	Sockel obh	28	lpm
	9205	12x69	Sockel grundmålad	35	lpm
	6205	12x69	Sockel Eklasyr	28	lpm
	4205	12x69	Sockel Ek lackad	35	lpm
	7705	12x70x4000	Sockel Ekfanerad lackad	10	st
	220644	12x95x4400	Sockel vit	10	st
	320644	12x95x4400	Sockel vit 0500-N	10	st
	5206	12x95	Sockel obh	18	lpm
	220844	15x56x4400	Sockel furu vit	8	st
	320944	15x56x4400	Sockel furu vit 0500-N	8	st
	220944	15x69x4400	Sockel furu vit	8	st
	230744	14x56x4400	Ventilerad sockel vit	8	st
	5307	14x56	Ventilerad sockel obh	25	lpm
	221044	15x56x4400	Sockel kabelsp. Vit	8	st
	7708	16x60x4000	Sockel kabelsp. Ekfanér lack	10	st

Sockel, profilerade		Dimension mm	Beskrivning	Enhet/bunt	Enhet
	5209	15x69	Sockel furu obh Skrea	28	lpm
	5210	15x95	Sockel furu obh Skrea	28	lpm
	221144	15x69x4400	Allmogesockel vit (308)	8	st
	221136	15x69x3600	Allmogesockel vit (308)	8	st
	321144	15x69x4400	Allmogesockel 0500-N (308)	8	st
	5211	15x69	Allmogesockel obh (308)	18	lpm
	5311	15x69	Allmogesockel obh B (308)	18	lpm
	221244	15x95x4400	Allmogesockel vit (310)	8	st
	321244	15x95x4400	Allmogesockel 0500-N (310)	8	st
	5212	15x95	Allmogesockel obh (310)	18	lpm
	5213	15x95	Allmogesockel obh B (310)	18	lpm
	221544	21x120x4400	Allmogesockel vit (312)	5	st
	5215	21x120	Allmogesockel obh B (312)	18	lpm
	223144	15x69x4400	Allmogesockel vit (330)	8	st
	5231	15x69	Allmogesockel obh (330)	18	lpm
	5232	15x95	Allmogesockel obh (331)	18	lpm

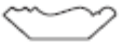
Socket, profilerade, forts	Dimension mm	Beskrivning	Enhet/bunt	Enhet
	223544 15x69x4400	Allmogesocket vit (338)		8 st
	5235 15x69	Allmogesocket obh (338)		18 lpm
	223644 15x95x4400	Allmogesocket vit (339)		8 st
	5236 15x95	Allmogesocket obh (339)		18 lpm
	223344 15x69x4400	Allmogesocket vit (337)		8 st
	5233 15x69	Allmogesocket obh (337)		18 lpm
	223444 15x95x4400	Allmogesocket vit (332)		8 st
	5234 15x95	Allmogesocket obh (332)		18 lpm
	923844 21x95x4400	Allmogesocket Grundm (343)		5 st
	5216 21x120	Allmogesocket obh B (343)		18 lpm
	5218 21x120	Allmogesocket obh (343)		18 lpm
	921844 21x120x4400	Allmogesocket Grundm.(343)		5 st
	5217 21x145	Allmogesocket obh B (346)		18 lpm
	5260 21x95	Allmogesocket West obh		18 lpm
	226144 21x120x4400	Allmogesocket West vit		5 st
	5261 21x120	Allmogesocket West obh		18 lpm
	226244 15x69x4400	Allmogesocket Syd vit		8 st
	5262 15x69	Allmogesocket Syd obh		18 lpm
	226344 15x95x4400	Allmogesocket Syd vit		8 st
	5263 15x95	Allmogesocket Syd obh		18 lpm
	2213 13x69	Antiksocket Furu vit		35 lpm
	5312 15x69	Antiksocket Furu B		18 lpm
	5313 15x95	Antiksocket Furu B		18 lpm
	2214 15x95	Antiksocket Furu vit		22 lpm
	2216 21x120	Antiksocket Furu vit		22 lpm

Taklister	Dimension mm	Beskrivning	Enhet/bunt	Enhet
	5621 12x27	Hålkäl obh		36 lpm
	262144 12x27x4400	Hålkäl vit		10 st
	261044 15x33x4400	Hålkäl vit		10 st
	361036 15x33x3600	Hålkärl vit 0500-N		10 st
	5610 15x33	Hålkäl obh		35 lpm
	261136 15x43x3600	Hålkäl vit		10 st
	261144 15x43x4400	Hålkäl vit		10 st
	361144 15x43x4400	Hålkäl vit 0500-N		10 st
	5611 15x43	Hålkäl obh		35 lpm
	9611 15x43	Hålkärl grundmålad		44 lpm
	261244 15x56x4400	Hålkäl vit		10 st
	361244 15x56x4400	Hålkäl vit 0500-N		10 st
	261236 15x56x3600	Hålkäl vit		10 st
	5612 15x56	Hålkäl obh		35 lpm
	9612 15x56	Hålkäl grundmålad		44 lpm
	261344 20x69x4400	Hålkäl vit		10 st

Taklister, forts.		Dimension mm	Beskrivning	Enhet/bunt	Enhet
		5613 20x69	Hålkäl obh	35 lpm	
		5615 21x95	Hålkäl obh	18 lpm	
		261444 15x43x4400	Bråttlist vit 135°	10 st	
		263144 21x33x4400	Enkelskugga vit	10 st	
		263136 21x33x3600	Enkelskugga vit	10 st	
		363044 21x33x4400	Enkelskugga 0500-N	10 st	
		9631 21x33x4400	Enkelskugga Grundmålad	44 lpm	
		5631 21x33	Enkelskugga obh	35 lpm	
		263244 21x43x4400	Dubbelskugga vit	10 st	
		263236 21x43x3600	Dubbelskugga vit	10 st	
		363444 21x43x4400	Dubbelskugga 0500-N	10 st	
		363436 21x43x3600	Dubbelskugga 0500-N	10 st	
		5632 21x43	Dubbelskugga obh	35 lpm	
		263344 33x43x4400	Skugglist vit	10 st	
		5633 33x43	Skugglist obh	35 lpm	
		5305 21x43	Trapplist obeh 354	20 lpm	
		260244 15x43x4400	Taklist vit Svanhals	10 st	
		5602 15x43	Taklist obh Svanhals	35 lpm	
		260344 15x56x4400	Taklist vit Svanhals	10 st	
		260336 15x56x3600	Taklist vit Svanhals	10 st	
		360336 15x56x3600	Taklist vit 0500-N Svanhals	10 st	
		5603 15x56	Taklist obh Svanhals	35 lpm	
		9603 15x56	Taklist grund Svanhals	44 lpm	
		260444 15x69x4400	Taklist vit Svanhals	8 st	
		5604 15x69	Taklist obh Svanhals	18 lpm	
		260544 21x69x4400	Allmogetaklist vit (362)	5 st	
		5605 21x69	Allmogetaklist obh (362)	18 lpm	
		260944 15x43x440	Bråttlist allmoge vit (411)	10 st	
		230444 15x69x4400	Allmogetaklist vit (363)	8 st	
		5304 15x69	Allmogetaklist obh (363)	18 lpm	
		5303 15x69	Allmogetaklist obh B (363)	18 lpm	
		5606 21x95	Allmogetaklist obh (381)	18 lpm	
		260844 15x69x4400	Hålkäl allmoge vit (369)	8 st	
		5608 15x69	Hålkäl allmoge obh (369)	18 lpm	

Bröstlister		Dimension mm	Beskrivning	Enhet/bunt	Enhet
	250544	21x45x4400	Bröstlist vit fals 12 mm	10 st	
	5505	21x45	Bröstlist obh fals 12 mm	35 lpm	
	2506	21x43x2400	Bröstlist vit 390 m fals 6mm	10 st	
	5506	21x43	Bröstlist obh 390	35 lpm	
	5507	33x43	Bröstlist obh 392	35 lpm	
	5508	21x33	Bröstlist obh 395 fals 12mm	35 lpm	
	251036	27x43x3600	Bröstlist vit	10 st	

Hörnlist		Dimension mm	Beskrivning	Enhet/bunt	Enhet
	243100	21x21x2700	Hörnlist vit 0500-N	10 st	
	2431	21x21x2700	Hörnlist vit	10 st	
	5431	21x21x2700	Hörnlist obh	10 st	
	443127	21x21x2700	Hörnlist Ek lackad	10 st	
	2433	27x27x2700	Hörnlist vit	10 st	
	5433	27x27x2700	Hörnlist obh	10 st	
	443327	27x27x2700	Hörnlist Ek lackad	10 st	
	2435	33x33x2700	Hörnlist vit	10 st	
	243500	33x33x2700	Hörnlist vit 0500-N	10 st	
	5435	33x33x2700	Hörnlist obh	10 st	
	2437	43x43x2700	Hörnlist vit	10 st	
	5437	43x43x2700	Hörnlist obh	10 st	

Flexilist MDF		Dimension mm	Beskrivning	Enhet/bunt	Enhet
	1661	25x25x2700	Flexilist vit MDF - folierad	20 st	
	166100	25x25x2700	Flexilist 0500-N MDF -folierad	20 st	
	1662	35x35x2700	Flexilist vit MDF - folierad	20 st	

Salningslister		Dimension mm	Beskrivning	Enhet/bunt	Enhet
	242022	19x27x2200	Salningslist vit	10 st	
	241922	19x27x2200	Salningslist vit 0500-N	10 st	
	242030	19x27x3000	Salningslist vit	10 st	
	242044	19x27x4400	Salningslist vit	10 st	
	24204400	19x27x4400	Salningslist vit 0500-N	10 st	
	240844	21x33x4400	Salningslist vit	6 st	
	2421	21x43x2200	Salningslist vit	6 st	
	242244	21x43x4400	Salningslist vit	6 st	
	342244	21x43x4400	Salningslist vit 0500-N	6 st	

Salningslister, forts.		Dimension mm	Beskrivning	Enhet/bunt	Enhet
	2423	21x69x2200	Salningslist vit	6	st
	242444	21x69x4400	Salningslist vit	6	st
	342444	21x69x4400	Salningslist vit 0500-N	6	st
	242544	21x95x4400	Salningslist vit	6	st
	342544	21x95x4400	Salningslist vit 0500-N	6	st
	2426	21x95x2200	Salningslist vit	6	st

Smyglister		Dimension mm	Beskrivning	Enhet/bunt	Enhet
	241044	8x15x4400	Smyglist vit	15	St
	5410	8x15	Smyglist vit	54	lpm
	241024	8x15x2400	Smyglist vit	15	st
	541024	8x15x2400	Smyglist obh	15	st
	4410	8x15	Smyglist Ek lackad	50	lpm
	441012	8x15x1200	Smyglist Ek lackad	35	st
	241144	8x21x4400	Smyglist vit	15	st
	341144	8x21x4400	Smyglist vit 0500-N	15	st
	5411	8x21	Smyglist obh	54	lpm
	241124	8x21x2400	Smyglist vit	15	st
	541124	8x21x2400	Smyglist obh	15	st
	4411	8x21	Smyglist Ek lackad	50	lpm
	4936	8x21	Smyglist Björk lackad	50	lpm
	241244	8x27x4400	Smyglist vit	15	st
	341244	8x27x4400	Smyglist vit 0500-N	15	st
	5412	8x27	Smyglist obh	54	lpm
	241224	8x27x2400	Smyglist vit	15	st
	541224	8x27x2400	Smyglist obh	15	st
	4412	8x27	Smyglist Ek lackad	50	lpm
	441212	8x27x1200	Smyglist Ek lackad	35	st
	241344	8x33x4400	Smyglist vit	15	st
	341344	8x33x4400	Smyglist vit 0500-N	15	st
	5413	8x33	Smyglist obh	54	lpm
	241324	8x33x2400	Smyglist vit	15	st
	541324	8x33x2400	Smyglist obh	15	st
	4413	8x33	Smyglist Ek lackad	50	lpm
	241444	8x43x4400	Smyglist vit	15	st
	341444	8x43x4400	Smyglist vit 0500-N	15	st
	5414	8x43	Smyglist obh	54	lpm
	241424	8x43x2400	Smyglist vit	15	st
	541424	8x43x2400	Smyglist obh	15	st
	4414	8x44	Smyglist Ek lackad	50	lpm
	2415	13x21x2200	Smyglist vit, rak bakkant	20	st
	3415	13x21x2200	Smyglist 0500-N, rak bak	20	st
	241744	15x21x4400	Smyglist vit	10	st
	241844	15x27x4400	Smyglist vit	10	st
241644	15x33x4400	Smyglist vit	10	st	
5416	15x33	Smyglist obh	35	lpm	
9416	15x33	Smyglist grundmålad	44	lpm	

Falsad fönstersmyg Furu	Dimension mm	Beskrivning	Enhet/bunt	Enhet
	2107	18x70x4400	Furusmyg fals vit -9,5x35	1 st
	2108	18x95x2400	Furusmyg fals vit -9,5x35	1 st
	2109	18x95x4400	Furusmyg fals vit -9,5x35	1 st
	2110	18x120x2400	Furusmyg fals vit -9,5x35	1 st
	2111	18x120x4400	Furusmyg fals vit -9,5x35	1 st
	3111	18x120x4400	Furusmyg fals -9,5x35 0500-N	1 st
	2112	18x145x2400	Furusmyg fals vit -9,5x35	1 st
	2113	18x145x4400	Furusmyg fals vit -9,5x35	1 st
	3113	18x145x4400	Furusmyg fals -9,5x35 0500-N	1 st
	2114	18x170x2400	Furusmyg fals vit -9,5x35	1 st
	2115	18x170x4400	Furusmyg fals vit -9,5x35	1 st
	3115	18x170x4400	Furusmyg fals -9,5x35 0500-N	1 st
	2116	18x195x2400	Furusmyg fals vit -9,5x35	1 st
	2117	18x195x4400	Furusmyg fals vit -9,5x35	1 st
	3117	18x195x4400	Furusmyg fals -9,5x35 0500-N	1 st
	2118	18x220x4400	Furusmyg fals vit -9,5x35	1 st
	2120	18x250x2400	Furusmyg fals vit -9,5x60	1 st
	2121	18x250x4400	Furusmyg fals vit -9,5x60	1 st
	3121	18x250x4400	Furusmyg fals -9,5x60 0500-N	1 st
	2123	18x300x4400	Furusmyg fals vit -9,5x60	1 st
	2124	18x350x2400	Furusmyg fals vit -9,5x60	1 st
	2125	18x350x4400	Furusmyg fals vit -9,5x60	1 st

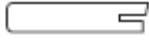
Spårad fönstersmyg MDF	Dimension mm	Beskrivning	Enhet/bunt	Enhet
	1101	16x75x2440	Smyg, spårad MDF	3 st
	1102	16x75x4200	Smyg, spårad MDF	3 st
	110200	16x75x4200	Smyg, spårad MDF 0500-N	3 st
	1103	16x100x2440	Smyg, spårad MDF	3 st
	1104	16x100x4200	Smyg, spårad MDF	3 st
	110400	16x100x4200	Smyg, spårad MDF 0500-N	3 st
	1105	16x125x2440	Smyg, spårad MDF	3 st
	1106	16x125x4200	Smyg, spårad MDF	3 st
	110600	16x125x4200	Smyg, spårad MDF 0500-N	3 st
	1107	16x150x2440	Smyg, spårad MDF	2 st
	1108	16x150x4200	Smyg, spårad MDF	2 st
	110800	16x150x4200	Smyg, spårad MDF 0500-N	3 st
	1109	16x175x2440	Smyg, spårad MDF	2 st
	1110	16x175x4200	Smyg, spårad MDF	2 st
	111000	16x175x4200	Smyg, spårad MDF 0500-N	3 st
	1111	16x200x2440	Smyg, spårad MDF	2 st
	1112	16x200x4200	Smyg, spårad MDF	2 st
	111200	16x200x4200	Smyg, spårad MDF 0500-N	2 st
	1113	16x250x2440	Smyg, spårad MDF	2 st
	1114	16x250x4200	Smyg, spårad MDF	2 st
	111400	16x250x4200	Smyg, spårad MDF 0500-N	2 st
	1115	16x300x2440	Smyg, spårad MDF	2 st
	1116	16x300x4200	Smyg, spårad MDF	2 st

Falsad fönstersmyg MDF	Dimension mm	Beskrivning	Enhet/bunt	Enhet
	1118	16x50x4200	Smyg, falsad MDF - 9,5x25	3 st
	1119	16x60x4200	Smyg, falsad MDF - 9,5x25	3 st
	1120	16x75x2440	Smyg, falsad MDF - 9,5x25	3 st
	1121	16x75x4200	Smyg, falsad MDF - 9,5x25	3 st
	1122	16x100x2440	Smyg, falsad MDF - 9,5x35	3 st
	1123	16x100x4200	Smyg, falsad MDF - 9,5x35	3 st
	112300	16x100x4200	Fönstersmyg fals 0500-N	3 st
	1124	16x125x2440	Smyg, falsad MDF - 9,5x35	3 st
	1125	16x125x4200	Smyg, falsad MDF - 9,5x35	3 st
	1126	16x150x2440	Smyg, falsad MDF - 9,5x35	2 st
	1127	16x150x4200	Smyg, falsad MDF - 9,5x35	2 st
	112700	16x150x4200	Fönstersmyg fals 0500-N	2 st
	1128	16x175x2440	Smyg, falsad MDF - 9,5x35	2 st
	1129	16x175x4200	Smyg, falsad MDF - 9,5x35	2 st
	1130	16x200x2440	Smyg, falsad MDF - 9,5x35	2 st
	1131	16x200x4200	Smyg, falsad MDF - 9,5x35	2 st
	113100	16x200x4200	Fönstersmyg fals 0500-N	2 st
	1132	16x250x2440	Smyg, falsad MDF - 9,5x60	2 st
	1133	16x250x4200	Smyg, falsad MDF - 9,5x60	2 st

Dörromfattning MDF	Dimension mm	Beskrivning	Enhet/bunt	Enhet
	1001	16x80x2440	Omfattning, 4 rk MDF	3 st
	100100	16x80x2440	Omfattning, 4 rk MDF 0500	3 st
	1002	16x80x4200	Omfattning, 4 rk MDF	3 st
	1003	16x95x2440	Omfattning, 4 rk MDF	3 st
	100300	16x95x2440	Omfattning, 4 rk MDF 0500	3 st
	1004	16x95x4200	Omfattning, 4 rk MDF	3 st
	1005	16x105x2440	Omfattning, 4 rk MDF	3 st
	100500	16x105x2440	Omfattning, 4 rk MDF 0500	3 st
	1006	16x105x4200	Omfattning, 4 rk MDF	3 st
	1007	16x120x2440	Omfattning, 4 rk MDF	3 st
	100700	16x120x2440	Omfattning, 4 rk MDF 0500	3 st
	1008	16x120x4200	Omfattning, 4 rk MDF	3 st
	1009	16x130x2440	Omfattning, 4 rk MDF	3 st
	100900	16x130x2440	Omfattning, 4 rk MDF 0500	3 st
	1010	16x130x4200	Omfattning, 4 rk MDF	3 st
	1011	16x145x2440	Omfattning, 4 rk MDF	3 st
	101100	16x145x2440	Omfattning, 4 rk MDF 0500	3 st
	1012	16x145x4200	Omfattning, 4 rk MDF	3 st
	1013	16x155x2440	Omfattning, 4 rk MDF	2 st
	101300	16x155x2440	Omfattning, 4 rk MDF 0500	2 st
1014	16x155x4200	Omfattning, 4 rk MDF	2 st	
1015	16x170x2440	Omfattning, 4 rk MDF	2 st	
1016	16x170x4200	Omfattning, 4 rk MDF	2 st	
1017	16x200x2440	Omfattning, 4 rk MDF	2 st	
101700	16x200x2440	Omfattning, 4 rk MDF 0500	2 st	
1018	16x200x4200	Omfattning, 4 rk MDF	2 st	

Foglisters/Täckbräda	Dimension mm	Beskrivning	Enhet/bunt	Enhet
	5400 6x21	Foglist obh	66 lpm	
	240024 8x15x2400	Foglist vit	15 st	
	540024 8x15x2400	Foglist obh	15 st	
	240144 8x21x4400	Foglist vit	15 st	
	5401 8x21	Foglist obh	54 lpm	
	240124 8x21x2400	Foglist vit	15 st	
	340144 8x21x4400	Foglist vit 0500-N	15 st	
	540124 8x21x2400	Foglist obh	15 st	
	4401 8x21	Foglist Ek lackad	50 lpm	
	240244 8x27x4400	Foglist vit	15 st	
	340244 8x27x4400	Foglist vit 0500-N	15 st	
	5402 8x27	Foglist obh	54 lpm	
	240224 8x27x2400	Foglist vit	15 st	
	540224 8x27x2400	Foglist obh	15 st	
	4402 8x27	Foglist Ek lackad	50 lpm	
	240344 8x33x4400	Foglist vit	15 st	
	340344 8x33x4400	Foglist vit 0500-N	15 st	
	340325 8x33x2500	Foglist vit 0500-N	15 st	
	5403 8x33	Foglist obh	54 lpm	
	240324 8x33x2400	Foglist vit	15 st	
	540324 8x33x2400	Foglist obh	15 st	
	4403 8x33	Foglist Ek lackad	50 lpm	
	240444 8x43x4400	Foglist vit	15 st	
	340444 8x43x4400	Foglist vit 0500-N	15 st	
	5404 8x43	Foglist obh	54 lpm	
	240424 8x43x2400	Foglist vit	15 st	
	540424 8x43x2400	Foglist obh	15 st	
	4404 8x44	Foglist Ek lackad	50 lpm	
	4405 8x95	Foglist Ek lackad	30 lpm	
	240944 21x27x4400	Foglist vit	10 st	
	242944 21x69x4400	Täckbräda vit	6 st	
	242922 21x69x2200	Täckbräda vit	6 st	
	342944 21x69x4400	Täckbräda vit 0500-N	6 st	
	2430440 21x95x4400	Täckbräda vit	6 st	
	2430 21x95x2200	Täckbräda vit	6 st	
	343044 21x95x4400	Täckbräda vit 0500-N	6 st	
	242744 21x120x4400	Täckbräda vit	3 st	
	242722 21x120x2200	Täckbräda vit	6 st	
	242844 21x145x4400	Täckbräda vit	3 st	
	242822 21x145x2200	Täckbräda vit	6 st	

Rundstav	Dimension mm	Beskrivning	Enhet/bunt	Enhet
	5461 8	Rundstav obeh	72 lpm	
	546125 8x2500	Rundstav obeh	20 st	
	5462 10	Rundstav obeh	72 lpm	
	546225 10x2500	Rundstav obeh	20 st	
	5463 12	Rundstav obeh	72 lpm	

Rundstav, forts.		Dimension mm	Beskrivning	Enhet/bunt	Enhet
	546325	12x2500	Rundstav obeh	20	st
	5464	15	Rundstav obeh	72	lpm
	546425	15x2500	Rundstav obeh	20	st
	5465	21	Rundstav obeh	54	lpm
	546525	21x2500	Rundstav obeh	20	st
	5466	25	Rundstav obeh	54	lpm
	546625	25x2500	Rundstav obeh	15	st
	5467	27	Rundstav obeh	54	lpm
	546725	27x2500	Rundstav obeh	15	st
	5468	33	Rundstav obeh	35	lpm
	546825	33x2500	Rundstav obeh	10	st
	5469	43	Rundstav obeh	35	lpm
	546925	43x2500	Rundstav obeh	10	st

Halvstav		Dimension mm	Beskrivning	Enhet/bunt	Enhet
	547825	33x2500	Halvstav obeh	10	st

Kvartstav		Dimension mm	Beskrivning	Enhet/bunt	Enhet
	244124	9x9x2400	Kvartstav vit	20	st
	544124	9x9x2400	Kvartstav obh	20	st
	4441	9x9	Kvartstav Ek lackad	50	lpm
	244244	12x12x4400	Kvartstav vit	20	st
	344244	12x12x4400	Kvartstav vit 0500-N	20	st
	5442	12x12	Kvartstav obeh	70	lpm
	244224	12x12x2400	Kvartstav vit	20	st
	544224	12x12x2400	Kvartstav obh	20	st
	6442	12x12	Kvartstav Ek lasyr	70	lpm
	4442	12x12	Kvartstav Ek lackad	50	lpm
	444212	12x12x1200	Kvartstav Ek lackad	35	st
	444224	12x12x2400	Kvartstav Ek lackad	20	st
	244344	15x15x4400	Kvartstav vit	20	st
	5443	15x15	Kvartstav obeh	70	lpm
	244324	15x15x2400	Kvartstav vit	20	st
	24432400	15x15x2400	Kvartstav vit 0500-N	20	st
	544324	15x15x2400	Kvartstav obh	20	st
	4443	15x15	Kvartstav Ek lackad	50	lpm
	444312	15x15x1200	Kvartstav Ek lackad	20	st
	444324	15x15x2400	Kvartstav Ek lackad	20	st
	244444	21x21x4400	Kvartstav vit	20	st
	5444	21x21	Kvartstav obeh	54	lpm
	244424	21x21x2400	Kvartstav vit	20	st
	544424	21x21x2400	Kvartstav obh	20	st
	4444	21x21	Kvartstav Ek lackad	50	lpm
	544524	27x27x2400	Kvartstav obeh	20	st



Trekantslist		Dimension mm	Beskrivning	Enhet/bunt	Enhet
		5449 15	Trekant Furu A	150 lpm	
		5450 21	Trekant Furu A	150 lpm	
		213GSF 21	Trekant Gran	60 lpm	

Kakellist		Dimension mm	Beskrivning	Enhet/bunt	Enhet
		246044 15x57x4400	Kakellist vit	10 st	

U-list		Dimension mm	Beskrivning	Enhet/bunt	Enhet
		247044 21x27x4400	U-list Furu vit	10 st	
		347044 21x27x4400	U-list Furu 0500-N	10 st	

Glaslist		Dimension mm	Beskrivning	Enhet/bunt	Enhet
		248044 11x23x4400	Glaslist Furu vit 424	10 st	
		5481 15x21	Glaslist Obh	36 lpm	

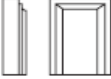
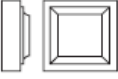
Dekorlist		Dimension mm	Beskrivning	Enhet/bunt	Enhet
		570124 8,5x22x2400	Dekorlist furu obeh	10 st	
		570224 12x34x2400	Dekorlist furu obeh	10 st	

Klossar		Dimension mm	Beskrivning	Enhet/bunt	Enhet
		27510028 75x100x28	Bottenkloss vit	2 frp	
		57510028 75x100x28	Bottenkloss obh	2 frp	
		210015528 100x155x28	Bottenkloss vit	2 frp	
		510015528 100x155x28	Bottenkloss obh	2 frp	
		310015528 100x155x28	Bottenkloss vit 0500-N	2 frp	
		2757528 75x75x28	Toppkloss vit	2 frp	
		5757528 75x75x28	Toppkloss obh	2 frp	
		210010028 100x100x28	Toppkloss vit	2 frp	
		510010028 100x100x28	Toppkloss obh	2 frp	
		23030100 30x30x100	Socketkloss innehörn vit	2 frp	
		53030100 30x30x100	Socketkloss innehörn obh	2 frp	
		23030155 30x30x155	Socketkloss innehörn vit	2 frp	
		53030155 30x30x155	Socketkloss innehörn obh	2 frp	
		24040155 40x40x155	Socketkloss ytterhörn vit	2 frp	
		54040155 40x40x155	Socketkloss ytterhörn obh	2 frp	
	52076300 20x76x300	Socketkloss Skrea obh	2 frp		
	520102300 20x102x300	Socketkloss Skrea obh	2 frp		
	525125300 25x125x300	Socketkloss Skrea obh	2 frp		







Klossar, forts.		Dimension mm	Beskrivning	Enhet/bunt	Enhet
	2353570	35x35x70	Takkloss innehörn vit	2 frp	
	5353570	35x35x70	Takkloss innehörn obh	2 frp	
	2505090	50x50x90	Takkloss innehörn vit	2 frp	
	5505090	50x50x90	Takkloss innehörn obh	2 frp	

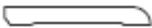

Kortlister	Dimension mm	Enhet/bunt	Enhet/bunt	Enhet
8576894	12x43x1000	Foder Furu vit	10 st	
8576895	12x56x1000	Foder Furu vit	10 st	
8576896	12x69x1000	Foder Furu vit	10 st	
8738669	8x1000	Rundstav obeh	20 st	
8576933	10x1000	Rundstav obeh	20 st	
8738668	15x1000	Rundstav obeh	20 st	
8576934	21x1000	Rundstav obeh	20 st	
8576955	25x1000	Rundstav obeh	20 st	
8576935	27x1000	Rundstav obeh	20 st	
8576936	33x1000	Rundstav obeh	20 st	
8576937	12x12x1000	Kvartstav obeh	20 st	
8576938	15x15x1000	Kvartstav obeh	20 st	
8576939	21x21x1000	Kvartstav obeh	20 st	
8576948	12x12x1000	Kvartstav vit	20 st	
8576949	15x15x1000	Kvartstav vit	20 st	
8738664	21x21x1000	Kvartstav vit	20 st	
444212	12x12x1200	Kvartstav Ek lackad	35 st	
8576940	8x21x1000	Foglist obeh	15 st	
8576941	8x27x1000	Foglist obeh	15 st	
8576942	8x33x1000	Foglist obeh	15 st	
8576953	8x43x1000	Foglist obeh	15 st	
8738661	8x21x1000	Foglist vit	15 st	
8738662	8x27x1000	Foglist vit	15 st	
8576956	8x33x1000	Foglist vit	15 st	
8738663	8x43x1000	Foglist vit	15 st	
8576943	8x15x1000	Smyglist Obeh	15 st	
8576944	8x21x1000	Smyglist Obeh	15 st	
8576945	8x27x1000	Smyglist Obeh	15 st	
8576957	8x15x1000	Smyglist vit	15 st	
8576958	8x21x1000	Smyglist vit	15 st	
8738670	8x27x1000	Smyglist vit	15 st	
441012	8x15x1200	Smyglist Ek lackad	35 st	
441212	8x27x1200	Smyglist Ek lackad	35 st	
8580112	21x21x1000	Hörnlist obeh	10 st	
8580113	27x27x1000	Hörnlist obeh	10 st	
8576974	21x21x1000	Hörnlist vit	10 st	
8576975	27x27x1000	Hörnlist vit	10 st	

Kortlister, forts.	Dimension mm	Enhet/bunt	Enhet/bunt	Enhet
	8576959 8x15x1000	Planhyvlat furu		15 st
	8738667 8x43x1000	Planhyvlat furu		10 st
	8576969 8x69x1000	Planhyvlat furu		10 st
	8576965 8x95x1000	Planhyvlat furu		10 st
	8738665 12x12x1000	Planhyvlat furu		10 st
	8576968 12x33x1000	Planhyvlat furu		10 st
	8576970 15x15x1000	Planhyvlat furu		10 st
	8576960 15x27x1000	Planhyvlat furu		6 st
	8738666 15x33x1000	Planhyvlat furu		6 st
	8576961 15x43x1000	Planhyvlat furu		5 st
	8576962 21x21x1000	Planhyvlat furu		6 st
	8576963 21x33x1000	Planhyvlat furu		4 st
	8576964 21x43x1000	Planhyvlat furu		4 st
	8576971 21x69x1000	Planhyvlat furu		4 st
	8576972 21x95x1000	Planhyvlat furu		4 st
	480512 8x95x1200	Planhyvlat Ek		10 st
	481312 15x70x1200	Planhyvlat Ek		6 st
	481412 15x95x1200	Planhyvlat Ek		6 st
	482112 21x70x1200	Planhyvlat Ek		4 st
	482212 21x95x1200	Planhyvlat Ek		4 st

	Planhyvlat	Dimension mm	Beskrivning	Enhet/bunt	Enhet
	5801	8x21	Planhyvlat furu		36 lpm
	5800	8x27	Planhyvlat furu		36 lpm
	5802	8x33	Planhyvlat furu		36 lpm
	5803	8x43	Planhyvlat furu		36 lpm
	5804	8x69	Planhyvlat furu		36 lpm
	4804	8x70	Planhyvlat Ek		35 lpm
	480412	8x70x1200	Planhyvlat Ek		10 st
	5805	8x95	Planhyvlat furu		36 lpm
	4805	8x95	Planhyvlat Ek		35 lpm
	4806	8x120	Planhyvlat Ek		35 lpm
	5807	12x21	Planhyvlat furu		36 lpm
	5838	12x33	Planhyvlat furu		22 lpm
	5839	12x44	Planhyvlat furu		22 lpm
	5808	15x15	Planhyvlat furu		36 lpm
	5809	15x21	Planhyvlat furu		22 lpm
	281044	15x27x4400	Planhyvlat furu vit		10 st
	5810	15x27	Planhyvlat furu		22 lpm
	5811	15x33	Planhyvlat furu		22 lpm
	581124	15x33x2400	Planhyvlat furu		6 st
	5812	15x43	Planhyvlat furu		18 lpm
	4812	15x44	Planhyvlat Ek		50 lpm
	281344	15x69x4400	Planhyvlat furu vit		10 st
	5813	15x69	Planhyvlat furu		18 lpm

Planhyvlat, forts.	Dimension mm	Beskrivning	Enhet/bunt	Enhet
581324	15x69x2400	Planhyvlad furu	5	st
4813	15x70	Planhyvlad Ek	25	lpm
5814	15x95	Planhyvlad furu	18	lpm
581424	15x95x2400	Planhyvlad furu	5	st
4814	15x95	Planhyvlad Ek	25	lpm
5815	15x118	Planhyvlad furu	18	lpm
4815	15x120	Planhyvlad Ek	25	lpm
5816	15x143	Planhyvlad furu	14	lpm
4816	15x145	Planhyvlad Ek	25	lpm
5817	21x21	Planhyvlad furu	22	lpm
4817	21x21	Planhyvlad Ek	35	lpm
5818	21x27	Planhyvlad furu	22	lpm
5819	21x33	Planhyvlad furu	14	lpm
4819	21x33	Planhyvlad Ek	35	lpm
282044	21x43x4400	Planhyvlad furu vit	10	st
5820	21x43	Planhyvlad furu	14	lpm
4820	21x44	Planhyvlad Ek	25	lpm
5836	21x56	Planhyvlad furu	14	lpm
5821	21x69	Planhyvlad furu	14	lpm
4821	21x70	Planhyvlad Ek	15	lpm
5822	21x95	Planhyvlad furu	14	lpm
4822	21x95	Planhyvlad Ek	15	lpm
5823	21x118	Planhyvlad furu	14	lpm
4823	21x120	Planhyvlad Ek	10	lpm
5824	21x143	Planhyvlad furu	14	lpm
4824	21x145	Planhyvlad Ek	10	lpm
5825	21x165	Planhyvlad furu	14	lpm
5841	21x185	Planhyvlad furu	14	lpm
4826	21x200	Planhyvlad Ek	10	lpm
5827	27x27	Planhyvlad furu	14	lpm
5828	27x69	Planhyvlad furu	14	lpm
5840	27x95	Planhyvlad furu	15	lpm
4829	27x95	Planhyvlad Ek	15	lpm
5829	27x118	Planhyvlad furu	14	lpm
5830	33x33	Planhyvlad furu	11	lpm
5837	33x43	Planhyvlad furu	11	lpm
5831	33x69	Planhyvlad furu	11	lpm
5832	33x95	Planhyvlad furu	11	lpm
5833	33x118	Planhyvlad furu	11	lpm
5834	33x143	Planhyvlad furu	11	lpm
5835	44x44	Planhyvlad furu	11	lpm
921B	69x69	Planhyvlad furu B 4rk	11	lpm

	Lister MDF	Dimension mm	Beskrivning	Enhet/bunt	Enhet
	1301	12x43x2200	Foder vit MDF	10 st	
	1302	12x43x4200	Foder vit MDF	10 st	
	1303	12x56x2200	Foder vit MDF	10 st	
	1304	12x56x4200	Foder vit MDF	10 st	
	1305	12x69x2200	Foder vit MDF	10 st	
	1306	12x69x4200	Foder vit MDF	10 st	
	1307	12x95x2440	Foder vit MDF	10 st	
	1308	12x95x4200	Foder vit MDF	10 st	
	1401	12x69x2200	Allmogefoder vit MDF	5 st	
	1402	12x69x4200	Allmogefoder vit MDF	5 st	
	1404	12x95x4200	Allmogefoder vit MDF	5 st	
	1405	16x69x2200	Allmogefoder vit MDF	5 st	
	1406	16x69x4200	Allmogefoder vit MDF	5 st	
	1407	16x95x2440	Allmogefoder vit MDF	5 st	
	1408	16x95x4200	Allmogefoder vit MDF	5 st	
	1351	12x43x4200	Sockel vit MDF	10 st	
	1352	12x56x4200	Sockel vit MDF	10 st	
	1353	12x69x4200	Sockel vit MDF	10 st	
	1453	16x69x4200	Allmogesockel vit MDF	5 st	
	1454	16x95x4200	Allmogesockel vit MDF	5 st	
	1713	15x56x4200	Allmogetaklist vit MDF	5 st	
	1732	15x56x4200	Hålkälslist vit MDF	5 st	

	Clips/ Bättringsfärg	Beskrivning	Enhet/bunt	Enhet
	8010	Dorn för metallclips	1 st	
	8011	Metallclips	400st/frp	Frp
	8013	Metallclips	50st/frp	Frp
	8015	Metallclips Skruv 1,25x40mm	250st/frp	Frp
	8020	Bättringsfärg S 0502-Y	1 st	
	8025	Bättringsfärg S 0500-N	1 st	

	Bastuartiklar	Dimension mm	Beskrivning	Enhet/bunt	Enhet
	7910	12x68	Bastupanel Asp	10st/bunt	lpm
	7920	21x65	Bastulav Asp	10st/bunt	lpm
	790524	12x42x2400	Bastufoder Asp	10 st	

Lustejp	Beskrivning	Enhet/bunt	Enhet
8050	Lustejp 20 mm, 100m/rulle	100m	Rulle
8055	12x56x3000 Sockel med lustejp Furu 0500-N	10	st
8056	12x56x3000 Sockel med lustejp Furu vit	10	st



Övrigt	Beskrivning	Enhet/bunt	Enhet
9001	Broschyr, sortimentslista	1	st





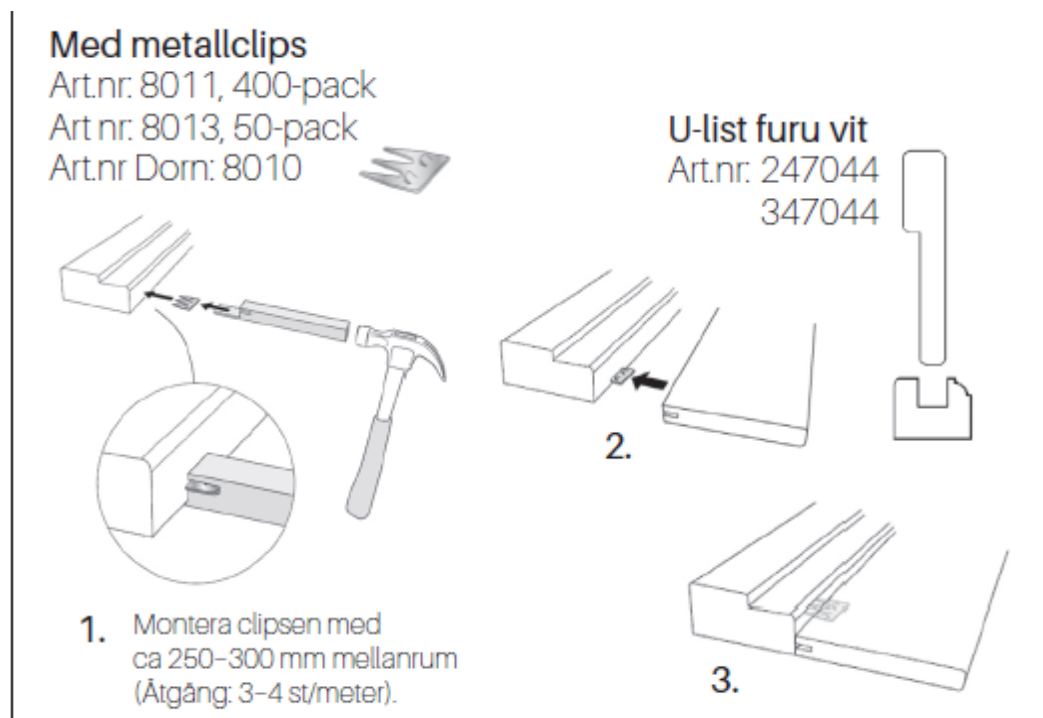















Diverse	Dimension mm	Beskrivning	Enhet/bunt	Enhet
43906713	2x25x2000	Skarvlist Aluminium	8	st
43906762	3x30x2000	Skarvlist Aluminium	8	st
43906758	40x15x2000	Trappnos Aluminium	8	st
43906781	15x15x2000	Vinkelprofil Aluminium	8	st
43906796	20x20x2000	Vinkelprofil Aluminium	8	st
43906815	30x30x2000	Vinkelprofil Aluminium	8	st
43906853	15x15x2000	Fyrkantsrör Aluminium	8	st
43906864	20x20x2000	Fyrkantsrör Aluminium	8	st
43906940	6x2000	Armeringsjärn Galv	8	st
43906955	8x2000	Armeringsjärn Galv	8	st
43906966	10x2000	Armeringsjärn Galv	8	st
43907076	25x25x2000	Vinkelprofil Järn Galv	8	st
43907080	38x38x2000	Vinkelprofil Järn Galv	8	st
43907125	15x15x2600	Hörnlist Pvc Vit	20	st
43907133	20x20x2600	Hörnlist Pvc Vit	20	st
43907144	25x25x2600	Hörnlist Pvc Vit	20	st
43907152	30x30x2600	Hörnlist Pvc Vit	20	st
43907163	35x35x2600	Hörnlist Pvc Vit	20	st
43907178	50x50x2600	Hörnlist Pvc Vit	20	st
43907235	18x21x2600	U-Profil Pvc Vit	10	st
43907265	13x24x2600	Sockellist Pvc Vit	10	st
43907292	2x20x2600	Täcklist Pvc Vit	20	st
43907303	2x30x2600	Täcklist Pvc Vit	20	st
43907318	15x15x2600	Hörnlist Pvc Svart	20	st
43907322	20x20x2600	Hörnlist Pvc Svart	20	st
43907337	25x25x2600	Hörnlist Pvc Svart	20	st
45232978	15x15x2600	Hörnlist Pvc Ekprofil	20	st
45232982	20x20x2600	Hörnlist Pvc Ekprofil	20	st
45233065	10x2000	Rör Aluminium	8	st
45233073	16x2000	Rör Aluminium	8	st
47504618	15x15x2000	Vinkelprofil Aluminium Lack	8	st
47504622	20x20x2000	Vinkelprofil Aluminium Lack	8	st
47504637	20x15x2000	Vinkelprofil Aluminium Lack	8	st

Monteringsanvisning Fönstersmyg

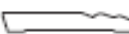

Samtliga lister i 0500-N	Dimension mm	Beskrivning	Enhet/bunt	Enhet
	300344 10x56x4400	Foder vit 0500-N		10 st
	300544 12x43x4400	Foder vit 0500-N		10 st
	200722 12x43x2200	Foder vit 0500-N		10 st
	301144 12x56x4400	Foder vit 0500-N		10 st
	301130 12x56x3000	Foder vit 0500-N		10 st
	201122 12x56x2200	Foder vit 0500-N		10 st
	201127 12x56x2700	Foder vit 0500-N		10 st
	200900 12x56x2200+1100	Foderset vit 0500-N		1 set
	301944 12x69x4400	Foder vit 0500-N		10 st
	201922 12x69x2200	Foder vit 0500-N		10 st
	301544 12x95x4400	Foder vit 0500-N		10 st
	201600 12x95x2200	Foder vit 0500-N		10 st
	302044 15x56x4400	Foder vit 0500-N		8 st
	202222 15x56x2200	Foder vit 0500-N		10 st
	3024 15x69x2200	Allmogefoder 0500-N (286)		10 st
	320244 12x43x4400	Sockel vit 0500-N		10 st
	320330 12x56x3000	Sockel vit 0500-N		10 st
	320344 12x56x4400	Sockel vit 0500-N		10 st
	320744 12x69x4400	Sockel vit 0500-N		10 st
	320644 12x95x4400	Sockel vit 0500-N		10 st
	320944 12x56x4400	Sockel vit 0500-N		10 st

Forts, lister i 0500-N		Dimension mm	Beskrivning	Enhet/bunt	Enhet
	321144	15x69x4400	Allmogesockel 0500-N (308)	8 st	
	321244	15x95x4400	Allmogesockel 0500-N (310)	8 st	
	361036	15x33x3600	Hålkärl vit 0500-N	10 st	
	361144	15x43x4400	Hålkärl vit 0500-N	10 st	
	361244	15x56x4400	Hålkäl vit 0500-N	10 st	
	360336	15x56x3600	Taklist vit 0500-N Svanhals	10 st	
	363044	21x33x4400	Enkelskugga 0500-N	10 st	
	363436	21x43x3600	Dubbelkugga 0500-N	10 st	
	363444	21x43x4400	Dubbelkugga 0500-N	10 st	
	243100	21x21x2700	Hörnlist vit 0500-N	10 st	
	243500	33x33x2700	Hörnlist vit 0500-N	10 st	
	166100	25x25x2700	Flexilist 0500-N MDF -folierad	20 st	
	241922	19x27x2200	Salningslist vit 0500-N	10 st	
	24204400	19x27x4400	Salningslist vit 0500-N	10 st	
	342244	21x43x4400	Salningslist vit 0500-N	6 st	
	342444	21x69x4400	Salningslist vit 0500-N	6 st	
	342544	21x95x4400	Salningslist vit 0500-N	6 st	
	341144	8x21x4400	Smyglist vit 0500-N	15 st	
	341244	8x27x4400	Smyglist vit 0500-N	15 st	
	341344	8x33x4400	Smyglist vit 0500-N	15 st	
	341444	8x43x4400	Smyglist vit 0500-N	15 st	
	3415	13x21x2200	Smyglist vit 0500-N	20 st	
	3111	18x120x4400	Furusmyg fals -9,5x35 0500-N	1 st	
	3113	18x145x4400	Furusmyg fals -9,5x35 0500-N	1 st	
	3115	18x170x4400	Furusmyg fals -9,5x35 0500-N	1 st	
	3117	18x195x4400	Furusmyg fals -9,5x35 0500-N	1 st	
	3121	18x250x4400	Furusmyg fals -9,5x35 0500-N	1 st	
	110200	16x75x4200	Smyg, spårad MDF 0500-N	3 st	
	110400	16x100x4200	Smyg, spårad MDF 0500-N	3 st	
	110600	16x125x4200	Smyg, spårad MDF 0500-N	3 st	
	110800	16x150x4200	Smyg, spårad MDF 0500-N	3 st	
	111000	16x175x4200	Smyg, spårad MDF 0500-N	3 st	
	111200	16x200x4200	Smyg, spårad MDF 0500-N	2 st	
	111400	16x250x4200	Smyg, spårad MDF 0500-N	2 st	
	112300	16x100x4200	Fönstersmyg fals 0500-N	3 st	
	112700	16x150x4200	Fönstersmyg fals 0500-N	2 st	
	113100	16x200x4200	Fönstersmyg fals 0500-N	2 st	

Samtliga lister i grundmålat	Dimension mm	Beskrivning	Enhet/bunt	Enhet
	9202 12x43	Foder grundmålad	44 lpm	
	9008 12x56	Foder grundmålad	44 lpm	
	9010 12x56x2200	Foder grundmålad	10 st	
	9013 12x69	Foder grundmålad	44 st	
	9017 15x33	Foder grundmålad	44 lpm	
	903844 21x95x4400	Allmogefoder grundmålad 343	5 st	
	9201 12x43	Sockel grundmålad	44 lpm	
	9204 12x56	Sockel grundmålad	44 lpm	
	9205 12x69	Sockel grundmålad	44 lpm	
	923844 21x95x4400	Allmogesockel Grundm.(343)	5 st	
	921844 21x120x4400	Allmogesockel Grundm.(343)	5 st	
	9611 15x43	Hålkärl grundmålad	44 lpm	
	9612 15x56	Hålkärl grundmålad	44 lpm	
	9603 15x56	Taklist grund Svanhals	44 lpm	
	9631 21x33x4400	Enkelskugga Grundmålad	44 lpm	
	9416 15x33	Smyglist grundmålad	44 lpm	

SimSALAbim-listen	Dimension mm	Beskrivning	Enhet/bunt	Enhet
	8030 18,9x23,2x4200	SimSALAbimlist	8 st	
	8031 18,9x23,2x2500	SimSALAbimlist	8 st	
	8035 70x70	Montagehörn SimSALAbim	4 st	



På vår webb finns en länk till en film om hur SimSALAbim-listen monteras:
www.ehlprolist.se